

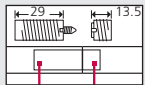

Invis Mx

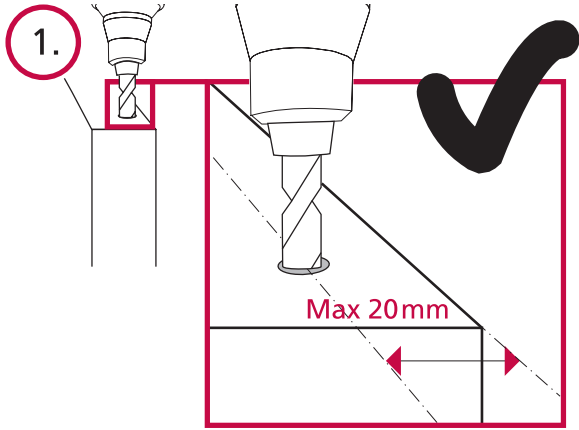

ø12 x 30mm

ø12 x 14mm

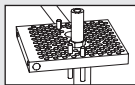

Rasto 126002

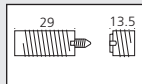

6012201



6012212



6012203

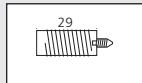

6012217

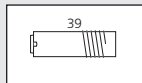

6012208

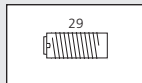

6012209

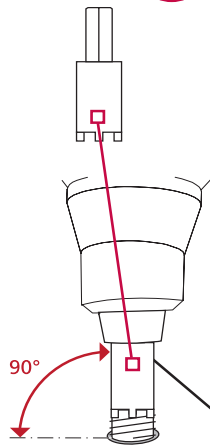

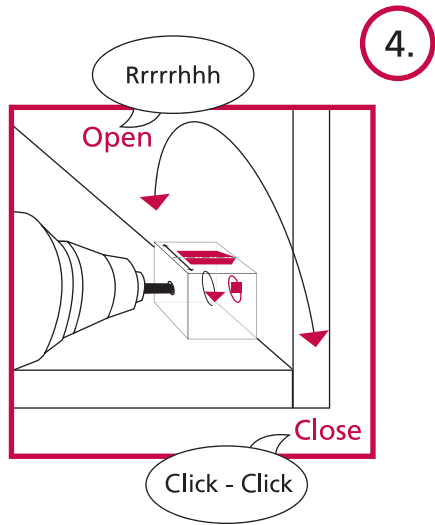
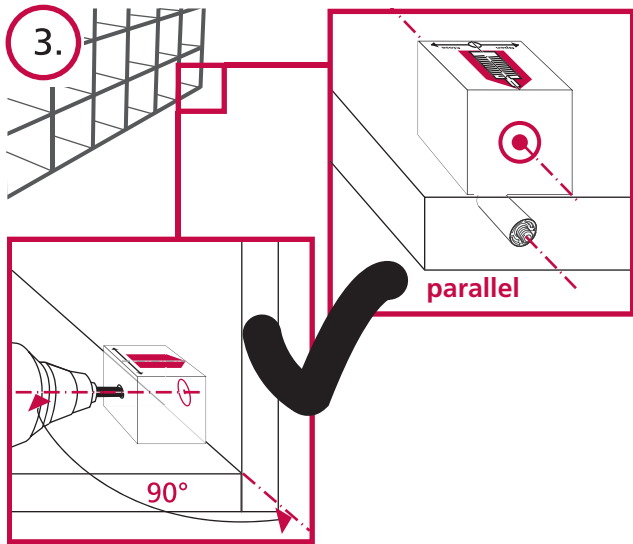

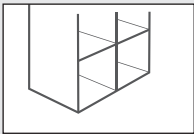

Mittelwand-Verbindungen
 Middle wall connections
 Assemblage des cloisons
 Middenwand verbindingen
 Perno distanziale per spalle centrali
 Conector con plano central

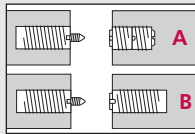
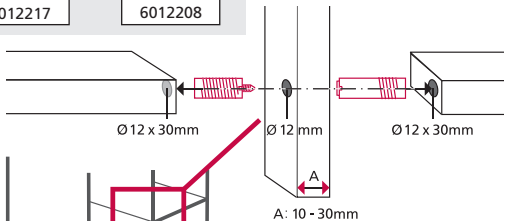
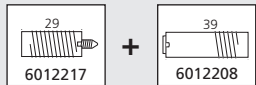

Erhöhung der Zugfestigkeit (Spanplatte)
 Increasing the tensile force (particule board)
 Augmentation de la force de traction (pann. de partic.)
 Vehoging van de trekkracht (spaanderplaat)
 Aumento della resistenza alla trazione (pann. truciolare)
 Aumento de la fuerza de tracción (aglomerado)

A

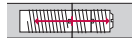

120 kg

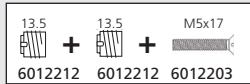
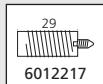

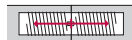

B

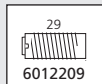

160 kg

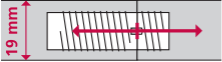

		
Buche Beech Hêtre Beuk Faggio Madera de haya	400 kg	200 kg
MDF	400 kg	150 kg
Fichte Spruce Epicéa Den Abete rosso Madera de picea	200 kg	100 kg
Spanplatte Chipboard Panneau de particules Spaanderplaat Pannello di truciolato Tablero aglomerado	160 kg	60 kg